



• • " ,

1 / SHAEC25021151206

fi fl / 2025 08 21

2 16

• • # \$ /

		SGS ID	
SN1	A1	SHA25-0211512-0001.C001	/

(1) 1 mg/kg = 1 ppm = 0.0001%

(2) MDL=





			MDL	A1
(NonaBDE)	-	mg/kg	25	ND
(DecaBDE)	-	mg/kg	25	ND
(2-) (DEHP)	1000	mg/kg	50	ND
(BBP)	1000	mg/kg	50	ND
(DBP)	1000	mg/kg	50	ND
(DIBP)	1000	mg/kg	50	ND

- (1) RoHS (EU) 2015/863
- (2) IEC 62321 EN 62321
- (3) 2021 7 22 DEHP BBP DBP DIBP

US EPA 3052:1996 ICP-OES/AAS

		MDL	A1
(As)	mg/kg	10	234
(Be)	mg/kg	5	ND
(Sb)	mg/kg	10	ND

EN 14582:2016 IC

		MDL	A1
(F)	mg/kg	20	ND
(Cl)	mg/kg	50	ND
(Br)	mg/kg	50	ND
(I)	mg/kg	50	ND

(MCCP) (C14-C17)

ISO 18219-2:2021 GC-NCI-MS

	CAS No.		MDL	A1
(MCCP) (C14-C17)	85535-85-9	mg/kg	50	ND

-A

US EPA 3540C: 1996, GC-MS/LC-MS



• • " •
• 1 /



• • " c

~ I / SHAEC25021151206

fi fl / 2025

08 21

5

16

(PFOS-Na)

4021-47-0

(PFOS-NH₄)

29081-56-9

(PFOS-NH₂(C₂H₄OH)₂)

70225-14-8

(PFOS-N(C₂H₅)₄)

56773-42-3

(PFOS-N(C₁₀H₂₁)₂(CH₃)₂)

251099-16-8

(PFOS-N(C₄H₉)₄)

111873-33-7

(PFOS-F)

307-35-7

[

] (PFOS-Mg)

91036-71-4

71463-74-6

45298-90-6

(PFOS-N(C₂H₅)₃)

54439-46-2

(PFOS-N(CH₃)₄)

56773-44-5

N, N,N-
N,N-

-1-

-1-

(PFOS-N(C₃H₇)₃(C₅H₁₁))

56773-56-9





(1:1) (PFOSA-K)	76752-70-0
(1:1) (PFOSA-NH ₄)	76752-72-2
(PFOSA-C ₆ H ₁₅ N)	76752-82-4
PFOA, &	
(PFOA)	335-67-1
(PFOA-Na)	335-95-5
(PFOA-K)	2395-00-8
(PFOA-Ag)	335-93-3
(PFOA-F)	335-66-0
(APFO)	3825-26-1
(PFOA-Li)	17125-58-5
(PFOA-Co)	35965-01-6
(PFOA-Cs)	17125-60-9
(3+) (PFOA-Cr(3+))	68141-02-6
- (2:1) (PFOA-NH(C ₄ H ₁₀ N))	423-52-9
	45285-51-6
	33496-48-9
	98241-25-9
	32609-65-7
	277749-00-5
(PFOA-K(H ₂ O) ₂)	98065-31-7
(PFOA-C ₂ H ₇ N)	1376936-03-6
(PFOA-C ₅ H ₅ N)	95658-47-2
(PFOA-C ₁₀ H ₁₄ N ₂)	1514-68-7
(PFOA-C ₁₁ H ₂₆ N)	927835-01-6
(PFOA-Cl)	335-64-8

SHAEC25021151202.

) |ANNEX III 7(c)-I| A1 (Pb) RoHS 2011/65/EU ()

<https://rohs.sgsonline.com.cn/PDFLinks/zh-cn/RSTS-TP-037%20RoHS%20Exemption%20%28CN%29.pdf>

ILAC-G8:09/2019

w=0





• • " •
x U

SHAEC25021151206

fi fl / 2025 08 21

7 16

T y ' ' z { |

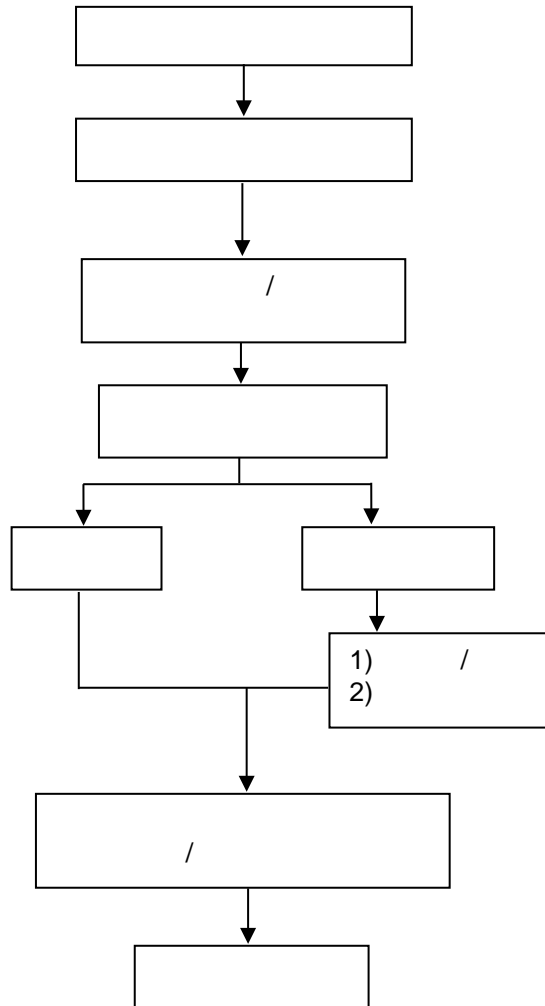



· · " ·
x U

± 2 3 · · z { |

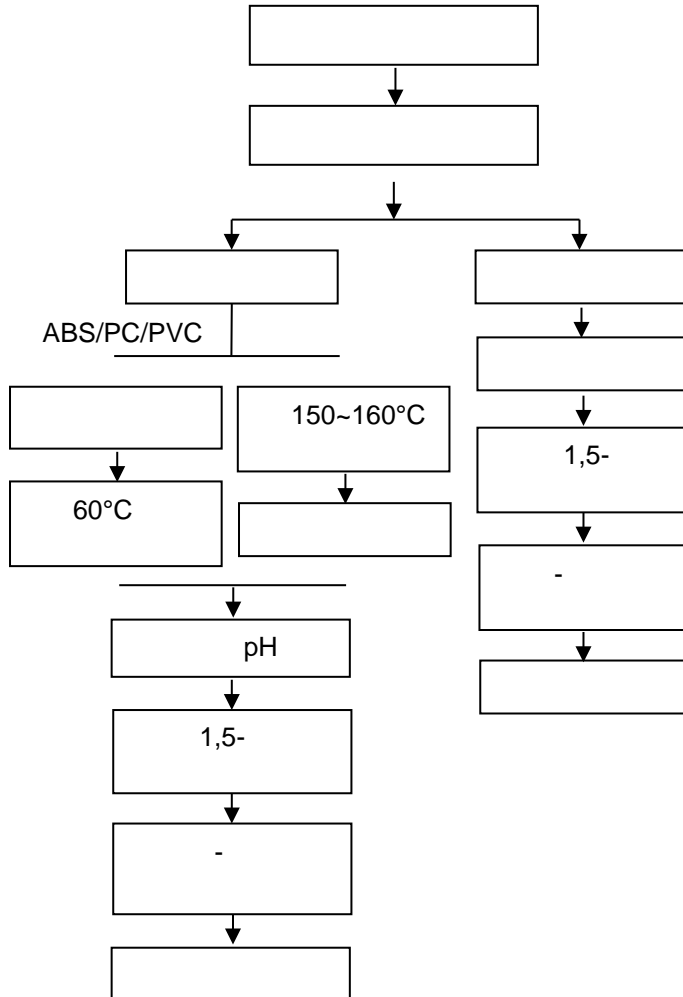



· · " ·
x U

~ I / SHAEC25021151206

fi fl / 2025 08 21

10

16

T y · ° z { |

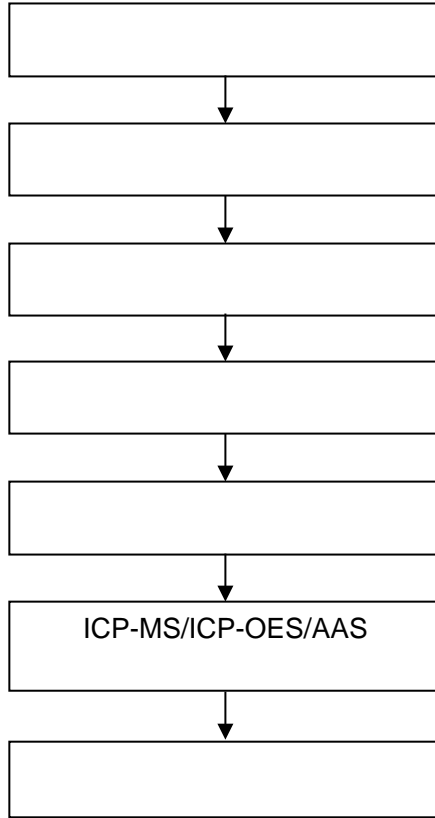



· · " ·
x U

~ I / SHAEC25021151206

fi fl / 2025 08 21

11

16

Øy · · z { |

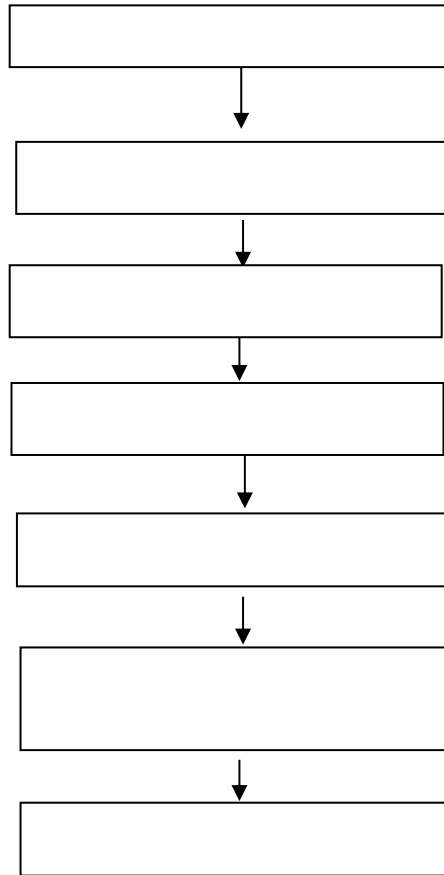



· ° “
x U

~ I / SHAEC25021151206

fi fl / 2025 08 21

12

16

ê © ë ì ' ° z { |

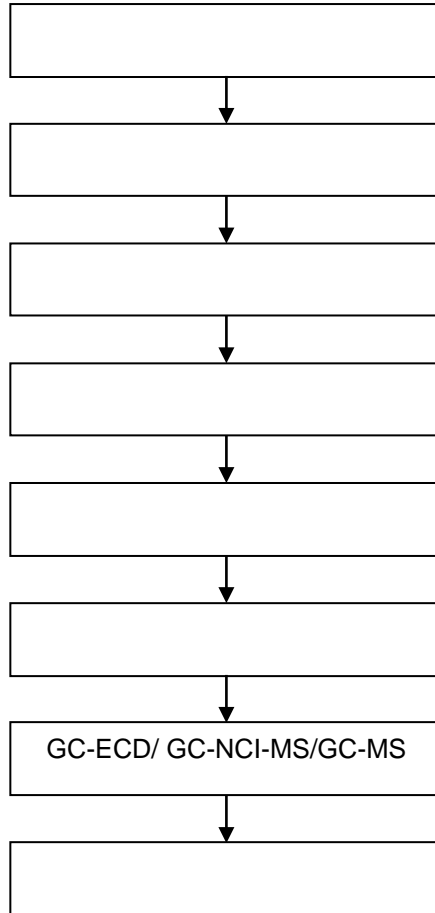



• • " •
x U

PFASs/ PFOS/PFOA

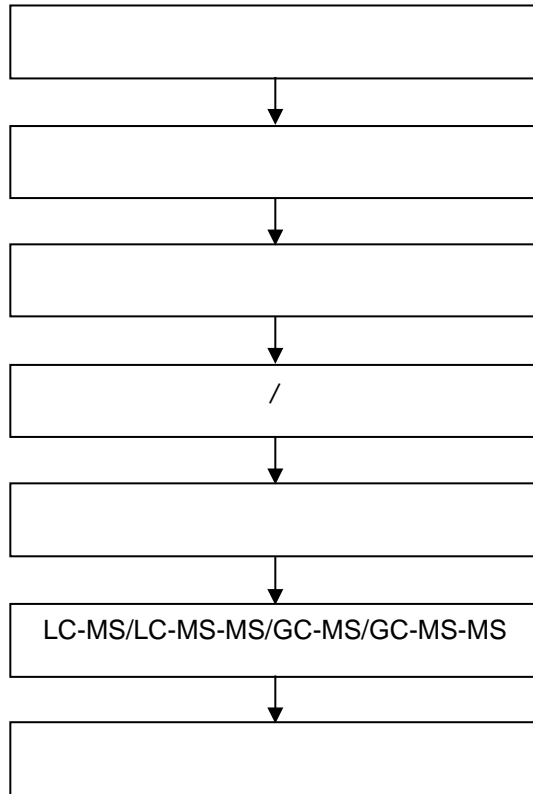

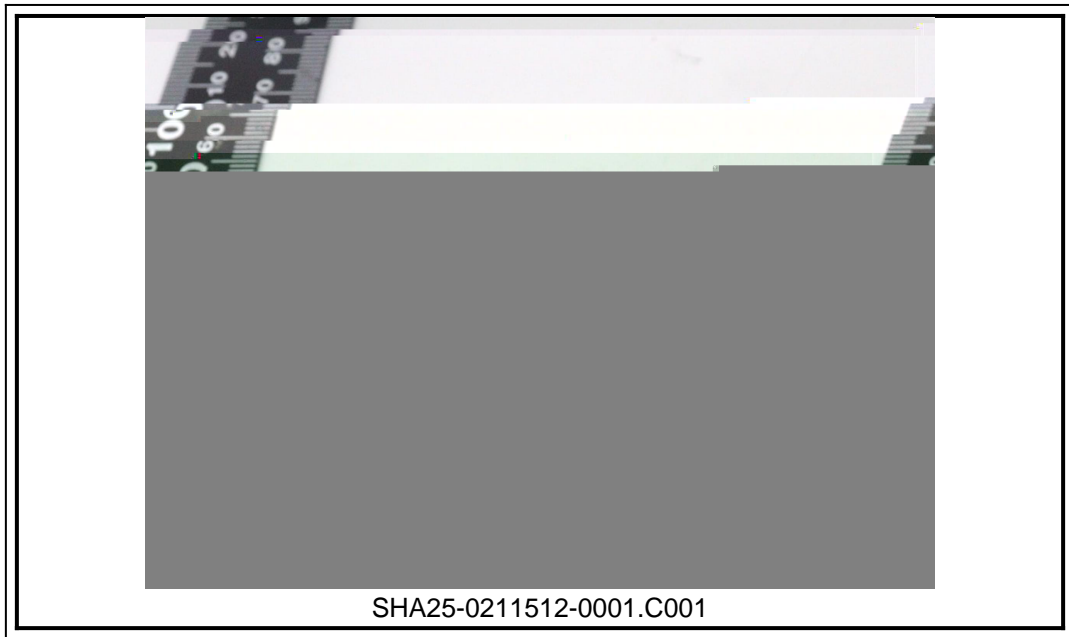

SGS

*** **

